

WLAN IEEE 802.11 evolution

Increasing speed from 1 Mbps (1997) to nearly 10 000 Mbps (2013)

- Max Riegel
- 2014-07-09

Outline

- Wi-Fi Market Evolution
- IEEE 802.11 Radio Evolution
 - IEEE 802.11b
 - IEEE 802.11a/g
 - IEEE 802.11n
 - IEEE 802.11ac
- Wi-Fi Spectrum
- What's next?
- IEEE 802.11 Specifications

Wi-Fi is becoming considered a basic need like food and water

WI-FI MARKET EVOLUTION

Wi-Fi market size evolution

Market size and diversity continues to increase

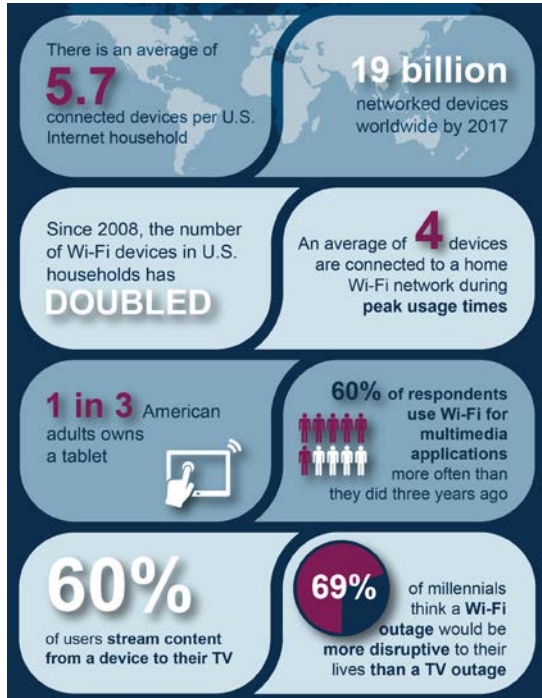

Source: WFA, Cisco, Pew Research Center, Wakefield Research

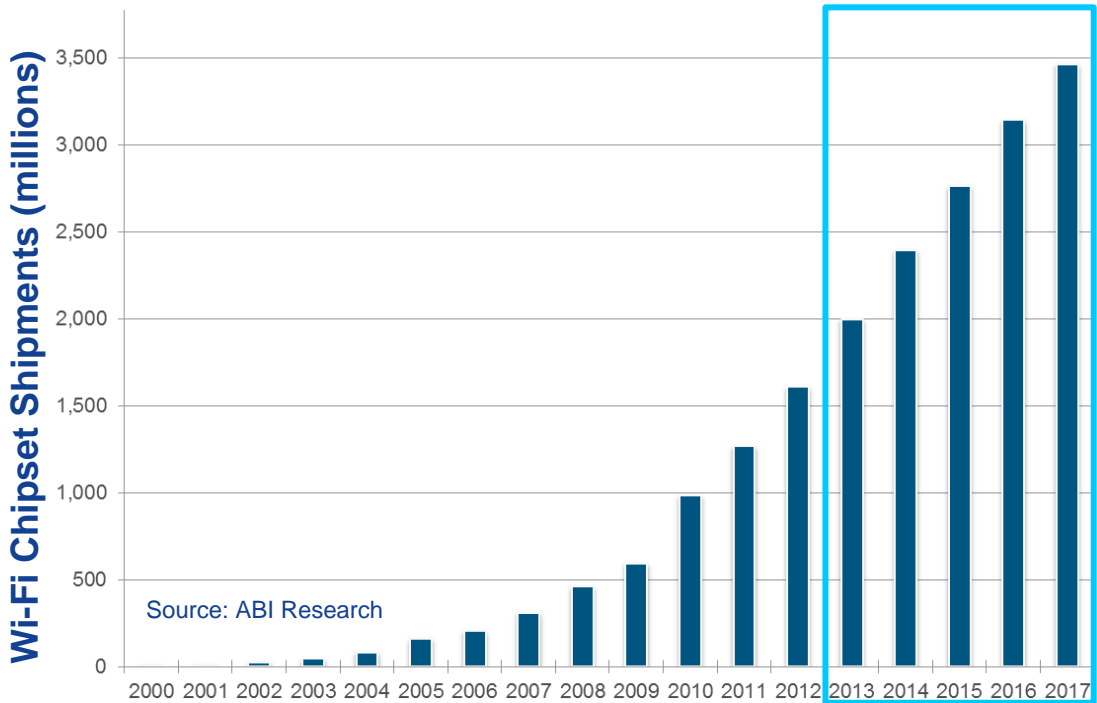

More diverse Wi-Fi devices mainly connected to home and enterprise Wi-Fi

Wi-Fi in smartphones is rarely used at operator controlled Wi-Fi access points

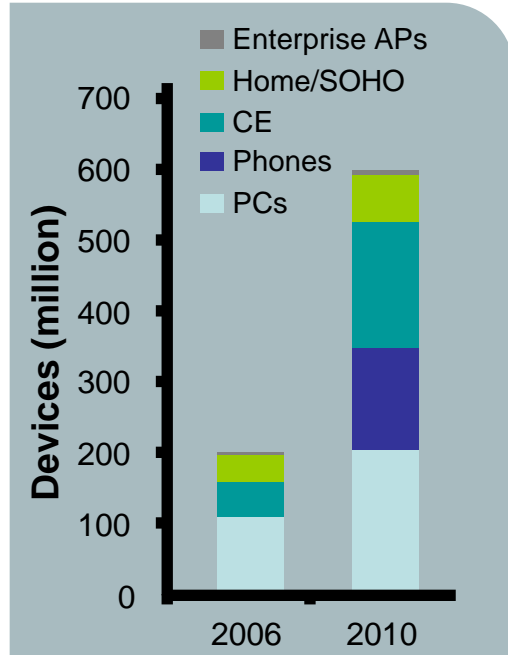

Source: In-Stat

~90%*

Residential Wi-Fi

- Currently managed by millions of 'hobby' operators
- Most heavy growth of Wi-Fi devices and data traffic
- Public co-use feasible but requires strict separation from privately operated part.

~10%*

Corporate Wi-Fi

- Managed by corporate IT departments
- Mission critical service with strict security policies in place
- Public access overlays for allowing employees to bring their own devices

<1%*

Public Wi-Fi

- Managed by public communication service providers or WISPs
- Cumbersome security and usability due to open Wi-Fi and portals
- Very good business potential in dense deployments

* Percentage of APs in segment; Source: ABIresearch 2010, Femtocells, Operator, Access Point and Chipset Market Analysis

Evolution of traffic volume of Wi-Fi and cellular

Wi-Fi will carry five times more traffic than cellular

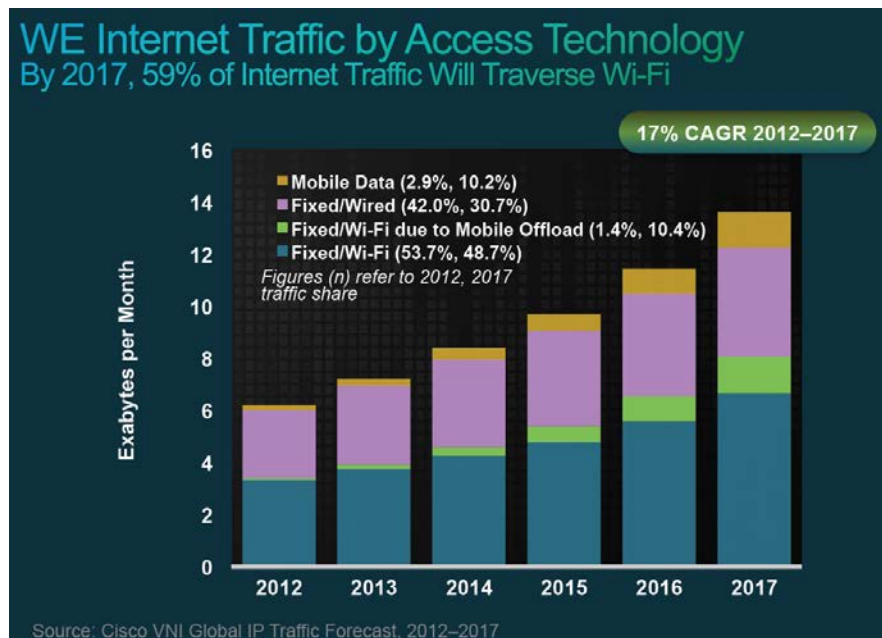

- Wi-Fi will continue to carry well more than 50% of all Internet traffic
- Internet traffic portion going over cellular will grow from 3% to about 10%
- Offloaded data to Wi-Fi volume will be about the same amount than cellular data in total
 - Recent Cisco results predicted growing offload portion
- Traffic volume relation Wi-Fi to cellular in 2017 will be about 6:1

Evolution of user experience of Wi-Fi and cellular

Wi-Fi will stay ahead in speed

Average global network connection speed

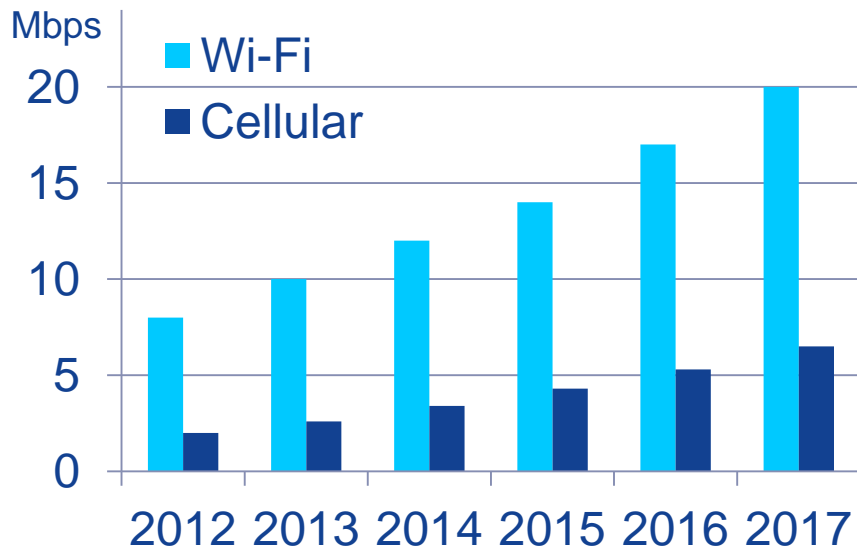

Source: Cisco VNI 2013

- Both Wi-Fi and cellular will become faster by about 25%/year in the coming years
- Wi-Fi will stay ahead to cellular by a factor of about 2 – 3
- Speed of Wi-Fi is mainly bound to the speed of fixed broadband connectivity
 - Radio interface would allow for more
- Cellular speed benefits by the vast introduction of 4G technology
 - US figures are showing highest speed in mobile networks

Consumer expectations on Wi-Fi

The hierarchy of human needs



Source: <http://imgur.com/Svw7vt7>

- Wi-Fi is becoming considered a basic need like food, water, shelter and warmth
 - In a couple of years all households will have Wi-Fi
- Free-of-charge Wi-Fi access is expected in public venues, hotels, coffee shops, shopping malls, airports, stations, trains, busses, ...
 - Charged access may still be accepted for premium locations or premium services
- Quality of 'free-of-charge' Wi-Fi access is becoming a differentiator for selecting goods and services
 - e.g. customers will avoid to stay in hotels with bad 'free' Wi-Fi

Speeding up from 1 Mbps to nearly 10 000 Mbps within 15 years

IEEE 802.11 RADIO EVOLUTION

IEEE802.11 (Wi-Fi) radio standards

Std	Release	Freq. (GHz)	Bandwidth (MHz)	Data rate per stream (Mbit/s)	Allowable MIMO streams	Modulation	Approximate indoor range (m)	Approximate outdoor range (m)
	Jun 1997	2.4	20	1, 2	1	DSSS	30	120
a	Sep 1999	5	20	6, 9, 12, 18, 24, 36, 48, 54	1	OFDM	30	120
b	Sep 1999	2.4	20	5.5, 11	1	DSSS	40	140
g	Jun 2003	2.4	20	6, 9, 12, 18, 24, 36, 48, 54	1	OFDM (DSSS)	40	140
n	Oct 2009	2.4/5	20	7.2, 14.4, 21.7, 28.9, 43.3, 57.8, 65, 72.2 ^[X]	4	OFDM	70	250
			40	15, 30, 45, 60, 90, 120, 135, 150 ^[X]			70	250
y	Nov 2008	3.7	5/10/20	Up to 13.5/27/54	1	OFDM		5 000
ac	Dec 2013	5	20/40/80/160	up to 867	8	OFDM	70	250
ad	Oct 2012	60	2000	up to 6 700	1		Single room	-
af	Dec 2013	TV WS	1,2,4x 6/7/8	up to 142	4	OFDM	200*	1000*
ah	~ 03/2016	< 1	1/2/4/8/16	tbd (up to 80)*	tbd	OFDM	200*	1000*
ax	~ 2017	1...6	tbd	tbd (>> 1Gbps)	tbd	OFDM ??	tbd	tbd

^[X]Assumes short guard interval (SGI) enabled, otherwise reduce each data rate by 10%.

* Preliminary information; specifications still in early phases of development.

IEEE 802.11y-2008 is only licensed in the United States by the FCC; licensed spectrum allows for higher TX power

Example of selective fading

WLAN operates in very challenging environments

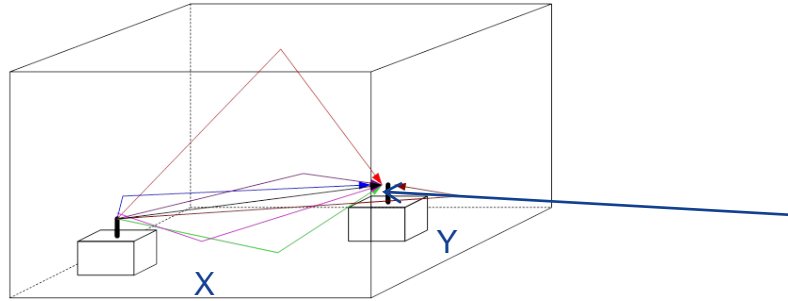

Use ray tracing to estimate delays

- Room 100ft by 70 feet (x, y)
- Ceiling 20ft
- RX position 65, 44 (3ft off ground)
- 10dB obstruction to direct and floor rays

Relative Selective Fading

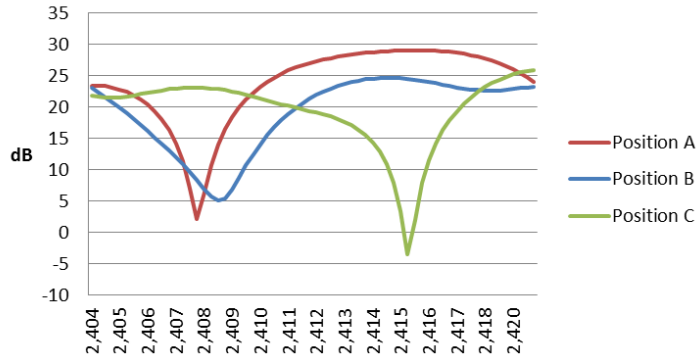

- Position A 21, 45 (delays 23 -100ns)
- Position B 30, 45 (delays 27 to 102ns)
- Position C 13, 45 (delays 21 to 99ns)

Fades up to 25 dB!

Source: IEEE 802.11-13/0416r5

OFDM (Orthogonal Frequency Devision Multiplexing) illustration

Transformation of high speed bit sequences into a lower number of symbols

	D	e	m	o
ASCII	68	101	109	111
128	0	0	0	0
64	1	1	1	1
32	0	1	1	1
16	0	0	0	0
8	0	0	1	1
4	1	1	1	1
2	0	0	0	1
1	0	1	1	1

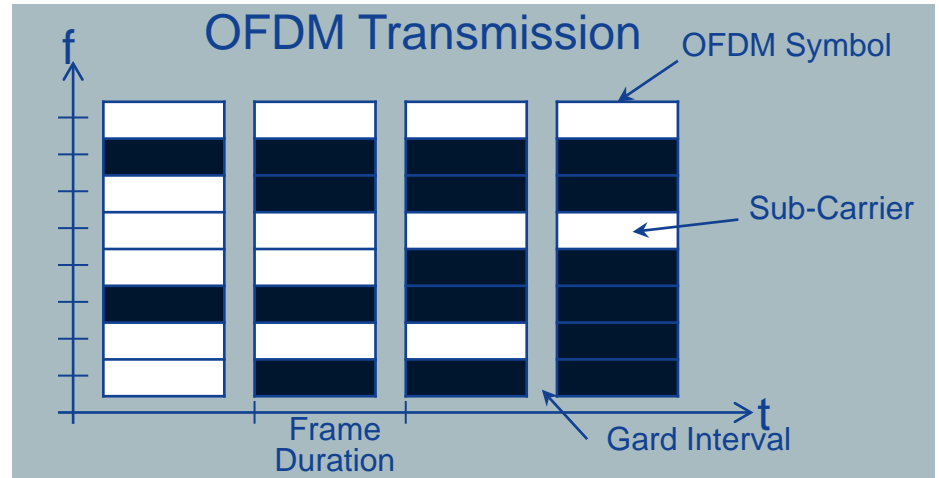
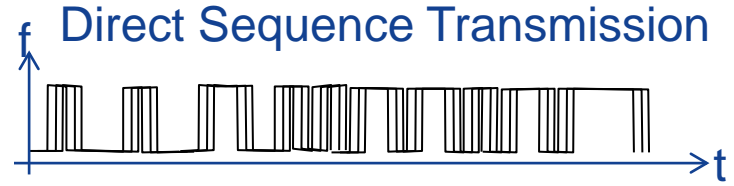

IEEE802.11 a/b/g – the early amendments to the standard

Comparison of bitrates vs. distance

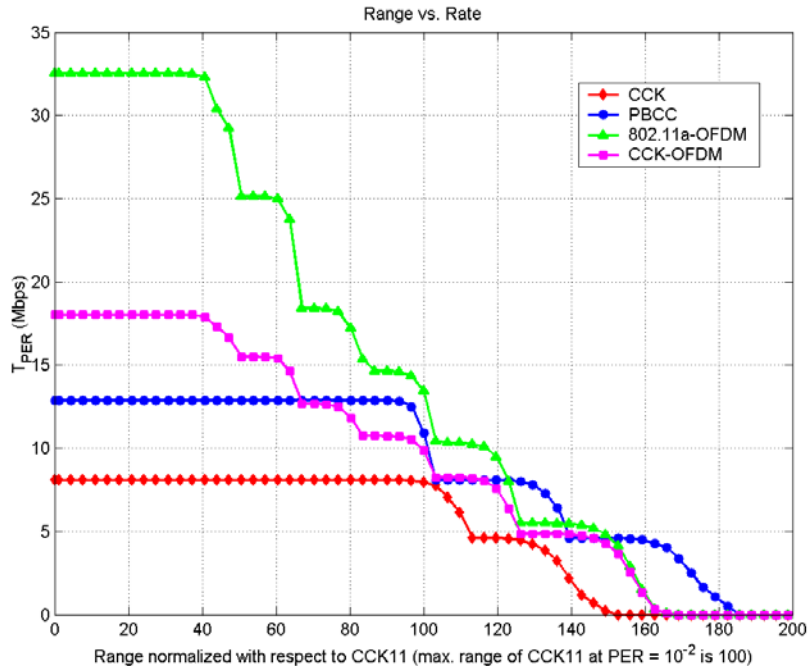

CCK (802.11b), OFDM ("802.11a, g"), PBCC, CCK-OFDM

Source: IEEE 802.11/01-286r2

- IEEE802.11b DSSS/CCK
 - Data rates: 1, 2, 5.5, 11Mbps
 - 22 MHz channel spacing
- IEEE802.11a/g OFDM
 - Data rates: 6, 12, 18, 24, 36, 48, 54Mbps
 - 48 sub-carriers
 - Sub-carrier modulation: BPSK, QPSK, 16QAM, 64QAM
 - Bit interleaved convolutional coding, K=7, R=1/2, 2/3, 3/4
 - OFDM frame duration: 4μs
 - Guard interval: 0.8μs
 - 18MHz channel spacing
 - 9-10 channels in 200MHz

OFDM Modulation and Coding Schemes (MCS)

Adaptation of OFDM to transmission channel characteristics

- MCS options for IEEE 802.11a and IEEE 802.11g

Data Rate (Mbps)	Modulation	Coding Rate	Coded Bits per Subcarrier	Coded Bits per OFDM Symbol	Data Bits per OFDM Symbol
6	BPSK	1/2	1	48	24
9	BPSK	3/4	1	48	36
12	QPSK	1/2	2	96	48
18	QPSK	3/4	2	96	72
24	16-QAM	1/2	4	192	96
36	16-QAM	3/4	4	192	144
48	16-QAM	2/3	6	288	192
54	64-QAM	3/4	6	288	216

- Various IEEE 802.11 reported (measured) throughputs

	(Mbps)	(Mbps)	(%)			(Mbps)	(Mbps)	(%)	
BPSK	1	0.81	81%		BPSK	1/2	6	4.64	77%
QPSK	2	1.58	79%		BPSK	3/4	9	6.55	73%
CCK	5.5	4.07	74%		QPSK	1/2	12	8.31	69%
CCK	11	7.18	65%		QPSK	3/4	18	11.5	64%
		avg	74.8%		16-QAM	1/2	24	14.18	59%
					16-QAM	3/4	36	18.31	51%
					64-QAM	1/2	48	23.25	48%
					64-QAM	3/4	54	26.12	48%

Huawei Quidway WA1006E Wireless Access Point (http://www.sersat.com/descarga/quidway_wa1006e.pdf)

IEEE 802.11 inefficiency by inter frame spaces

CSMA/CD requires silent periods for sensing

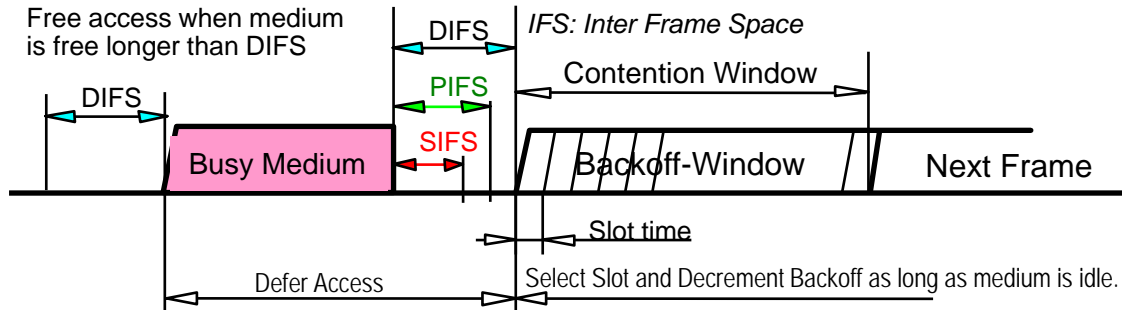

Standard	Slot time (μs)	DIFS (μs)
IEEE 802.11b	20	50
IEEE 802.11a (5G)	9	34
IEEE 802.11g	9 / 20	28 / 50
IEEE 802.11n	9 / 20	28 / 50
IEEE 802.11n (5G)	9	34
IEEE 802.11ac (5G)	9	34

- Reduce collision probability where mostly needed.
 - Stations are waiting for medium to become free.
 - Select random backoff after a defer, resolving contention to avoid collisions.
- Efficient backoff algorithm stable at high loads.
 - Exponential backoff window increases for retransmissions.
 - Backoff timer elapses only when medium is idle.
- Can be used to implement different predefined priority levels

IEEE 802.11 inefficiency by preambles

PLCP preamble allows for signal detection and synchronization

Long Preamble:

- Compatible with legacy IEEE 802.11 systems operating at 1 and 2 Mbps (Megabits per second)
- PLCP with long preamble is transmitted at 1 Mbps regardless of transmit rate of data frames
- Total Long Preamble transfer time is a constant at 192µs

Short Preamble:

- PLCP with short preamble: Preamble is transmitted at 1 Mbps and header at 2 Mbps for systems supporting 802.11b
- Total Long Preamble transfer time is a constant at 96µs

OFDM Preamble

- For OFDM-only systems, also referred to as OFDM training structure with 10 short symbols + 2 long symbols
- Total OFDM Preamble transfer time is a constant at 20µs

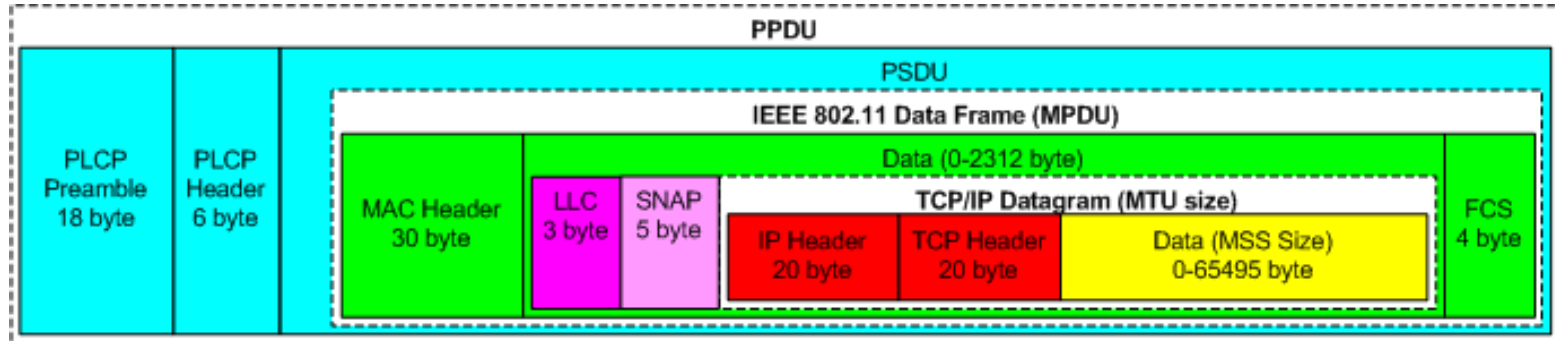

IEEE 802.11n-2009 (High Throughput)

Amendment to IEEE 802.11-2007 (a/b/g) for support of up to 600 Mbps

- Main techniques deployed for increase of bitrate:
 - Up to 4 parallel streams by multiple-input multiple-output (MIMO)
 - Twice the channel bandwidth by 40 MHz channels
 - Improved MAC efficiency by frame aggregation to the MAC layer.
- MCS Options for single stream of IEEE 802.11n:
 - Multiply by number of streams for multiple streams.

MCS index	Spatial streams	Modulation type	Coding rate	Data rate (Mbit/s)			
				20 MHz channel		40 MHz channel	
				800 ns GI	400 ns GI	800 ns GI	400 ns GI
0	1	BPSK	1/2	6.50	7.20	13.50	15.00
1	1	QPSK	1/2	13.00	14.40	27.00	30.00
2	1	QPSK	3/4	19.50	21.70	40.50	45.00
3	1	16-QAM	1/2	26.00	28.90	54.00	60.00
4	1	16-QAM	3/4	39.00	43.30	81.00	90.00
5	1	64-QAM	2/3	52.00	57.80	108.00	120.00
6	1	64-QAM	3/4	58.50	65.00	121.50	135.00
7	1	64-QAM	5/6	65.00	72.20	135.00	150.00

IEEE 802.11n Frame Aggregation

MAC efficiency enhancements by aggregation and block announcements

(a) No Aggregation

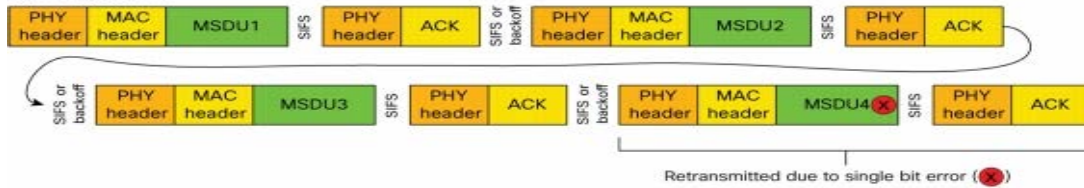

(b) A-MPDU Aggregation

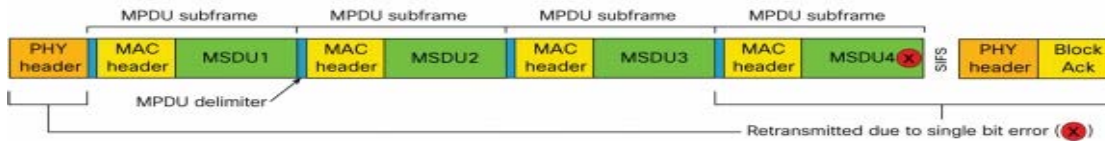

(c) A-MSDU Aggregation

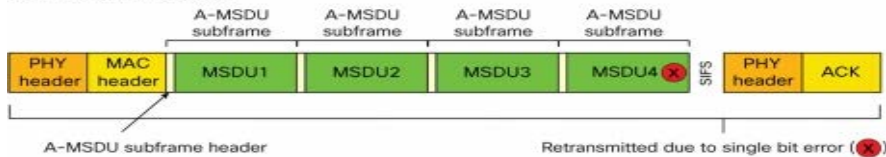

(d) A-MPDU of A-MSDU Aggregation

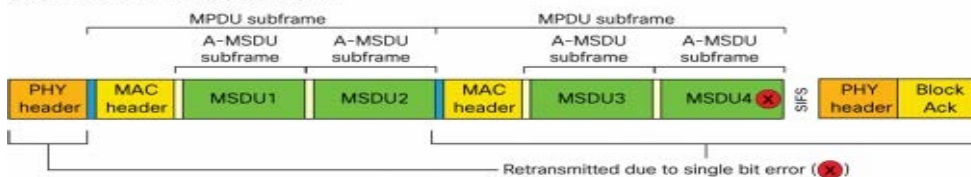

- **Block Acknowledgements** for reduction of ACKs to one per multiple transmission frames

- **Frame Aggregation** increases the payload that can be carried within a single 802.11 physical layer frame

- **MAC Protocol Data Unit Aggregation (A-MPDU)** groups multiple MPDU sub-frames each with its own MAC.

- PSDU up to 65535 bytes.

- **MAC Service Data Unit Aggregation (A-MSDU)** groups multiple MSDUs all with the same 802.11e QoS

- PSDU with a MAC header, followed by up to 7935 MSDU bytes.

IEEE 802.11n MIMO

Multiplying throughput by multiple parallel streams

Three different MIMO techniques specified in the standard:

- **Spatial Multiplexing (SM)**

- Subdivides an outgoing signal stream into multiple pieces, transmitted through different antennas.
- When individual streams are received with sufficiently distinct spatial signatures, an SM enabled receiver can reassemble the multiple pieces back into one stream
- Maximizes data rate.

- **Space-Time Block Coding (STBC)**

- Sends an outgoing signal stream redundantly, using different coding for each of the transmit antennas
- Receiver has a better chance of accurately decoding the original signal stream in the presence of RF interference and distortion.
- STBC improves reliability by reducing the error rate and may be combined with SM.

- **Transmit Beamforming (TxBF)**

- Steers signal stream towards the intended receiver by concentrating transmitted RF energy in a given direction.
- Leverages signal reflection and multipath to improve received signal strength and sustain higher data rates.
- Required channel knowledge can be obtained implicitly or explicitly by obtaining feedback from the receiver

Only Spatial Multiplexing is part of Wi-Fi certification of IEEE 802.11n-2009

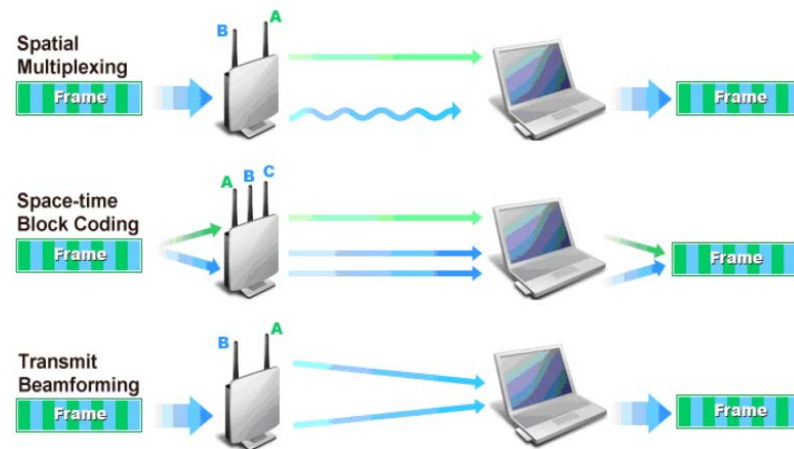

IEEE 802.11ac Very High Throughput 5G

Breaking the gigabit barrier with WLAN

- **Wider channel bandwidths**

- 80 MHz and 160 MHz channels (vs. 40 MHz maximum in 802.11n)

- **More MIMO spatial streams**

- Support for up to 8 spatial streams

- **Multi-user MIMO (MU-MIMO)**

- Multiple STAs, each with one or more antennas, transmit or receive independent data streams simultaneously

- **Other elements/features**

- **256-QAM**, rate 3/4 and 5/6, added as optional modes (vs. 64-QAM, rate 5/6 maximum in 802.11n)
- Single sounding and feedback format for **beamforming** (vs. multiple in 802.11n)
- MAC modifications (mostly to support above changes)
- Coexistence mechanisms for 20/40/80/160 MHz channels, 11ac and 11a/n devices

Theoretical throughput for single Spatial Stream (in Mbps)										
MCS	Modulation type	Coding rate	20 MHz channels		40 MHz channels		80 MHz channels		160 MHz channels	
			800ns GI	400ns GI	800ns GI	400ns GI	800ns GI	400ns GI	800ns GI	400ns GI
0	BPSK	1/2	6.5	7.2	13.5	15	29.3	32.5	58.5	65
1	QPSK	1/2	13	14.4	27	30	58.5	65	117	130
2	QPSK	3/4	19.5	21.7	40.5	45	87.8	97.5	175.5	195
3	16-QAM	1/2	26	28.9	54	60	117	130	234	260
4	16-QAM	3/4	39	43.3	81	90	175.5	195	351	390
5	64-QAM	2/3	52	57.8	108	120	234	260	468	520
6	64-QAM	3/4	58.5	65	121.5	135	263.3	292.5	526.5	585
7	64-QAM	5/6	65	72.2	135	150	292.5	325	585	650
8	256-QAM	3/4	78	86.7	162	180	351	390	702	780
9	256-QAM	5/6	N/A	N/A	180	200	390	433.3	780	866.7

Multi-User MIMO and Beamforming

Increasing signal quality and spectrum reuse by directional behavior

- An IEEE 802.11ac AP is able to use its antenna resources to transmit multiple frames to different clients.
 - all at the same time and over the same frequency spectrum.
- To send data to a particular user, the AP forms a strong beam toward that user
 - minimizing at the same time the signal strength in the direction of the other users (“null steering”)
- Each of the users receives a strong signal of the desired data that is only slightly degraded by interference from data for the other users.
- AP has to know about the channel conditions to all connected terminals, detected
 - either detected implicitly out of the received signal, or
 - explicitly by the 802.11ac sounding protocol.
- By serving clients in parallel MU-MIMO allows to deliver more data in sum to clients being limited to a single or dual antenna.

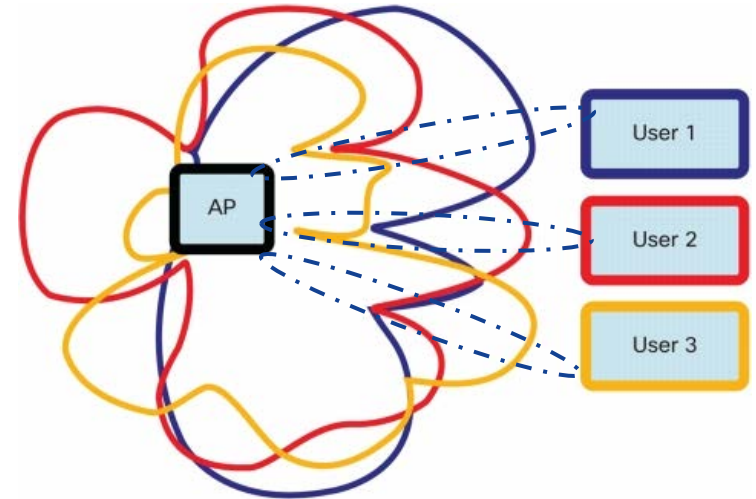

Figure: MU- MIMO with combination of Beamforming and Null Steering

IEEE 802.11ac performance figures for different deployment scenarios

Wide range of capabilities depending of AP capabilities

Scenario	Typical Client Form Factor	PHY Link Rate	Aggregate Capacity
1-antenna AP, 1-antenna STA, 80 MHz	Handheld	433 Mbps	433 Mbps
2-antenna AP, 2-antenna STA, 80 MHz	Tablet, Laptop	867 Mbps	867 Mbps
1-antenna AP, 1-antenna STA, 160 MHz	Handheld	867 Mbps	867 Mbps
2-antenna AP, 2-antenna STA, 160 MHz	Tablet, Laptop	1.69 Gbps	1.69 Gbps
4-antenna AP, four 1-antenna STAs, 160 MHz (MU-MIMO)	Handheld	867 Mbps to each STA	3.39 Gbps
8-antenna AP, 160 MHz (MU-MIMO) -- one 4-antenna STA -- one 2-antenna STA -- two 1-antenna STAs	Set-top Box, Tablet, Laptop, PC, Handheld	3.39 Gbps to 4-antenna STA 1.69 Gbps to 2-antenna STA 867 Mbps to each 1-antenna STA	6.77 Gbps
8-antenna AP, four 2-antenna STAs, 160 MHz (MU-MIMO)	Digital TV, PC, Tablet, Laptop,	1.69 Gbps to each STA	6.77 Gbps

Radio systems demand spectrum

WI-FI SPECTRUM

Wi-Fi in the 2.4 GHz ISM band

Most heavily used spectrum in the world

- Most of the Wi-Fi systems today operate in the 2.4 GHz ISM band
 - IEEE 802.11b set the rule to deploy systems on channel 1 – 6 – 11
 - Plain IEEE 802.11 g/n (OFDM) systems would not interfere when operation on channel 1 – 5 – 9 – 13
- Avoid interference with two adjacent channels by configuration of channels in the middle.

Non-Overlapping Channels for 2.4 GHz WLAN

802.11b (DSSS) channel width 22 MHz

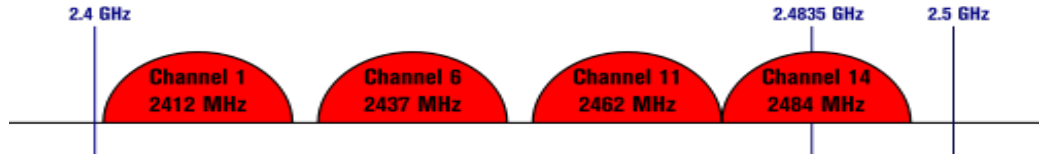

802.11g/n (OFDM) 20 MHz ch. width – 16.25 MHz used by sub-carriers

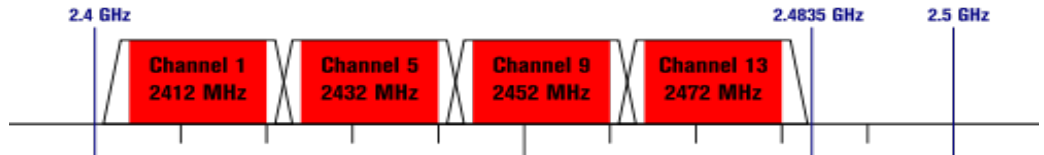

802.11n (OFDM) 40 MHz ch. width – 33.75 MHz used by sub-carriers

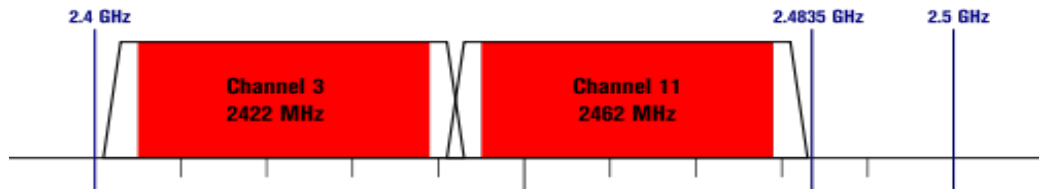

5GHz spectrum issues

Wide bandwidth channels desired to support high throughput requirements

- Non-overlapping channels to avoid co-channel interference desired for good QoS
- Current UNII spectrum allows only
 - **Six** 80 MHz channels or **Two** 160 MHz channels
- Additional unlicensed use of 5.35-5.47 GHz and 5.85-5.925 GHz would allow
 - **Nine** 80 MHz channels or **Four** 160 MHz channels
- Discussions in US leading global developments

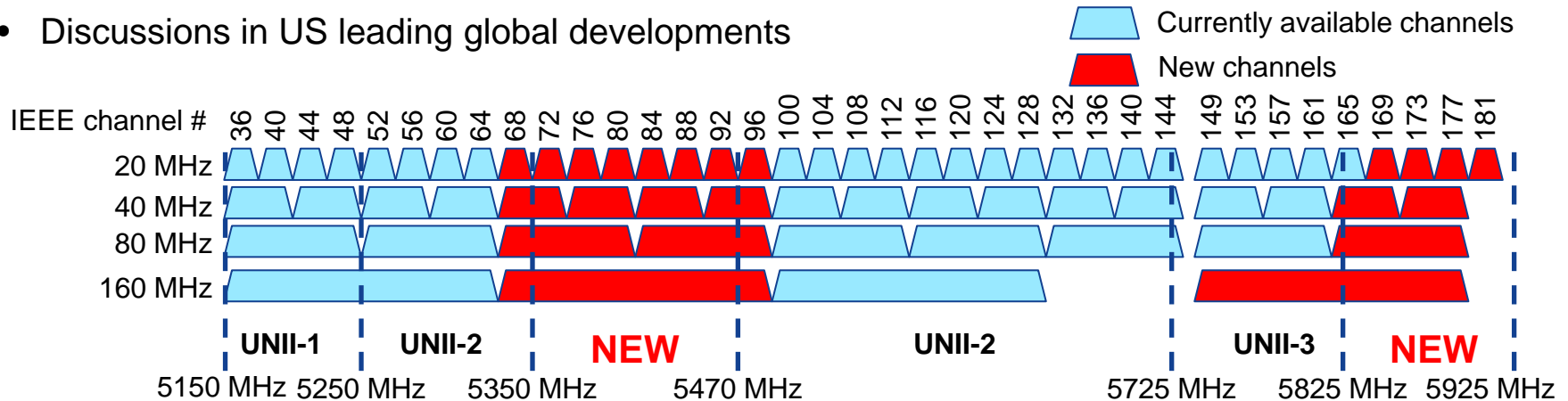

IEEE 802.11 continues to evolve

WHAT'S NEXT?

IEEE 802.11 standards evolution

The working group concurrently operates in different standardization phases

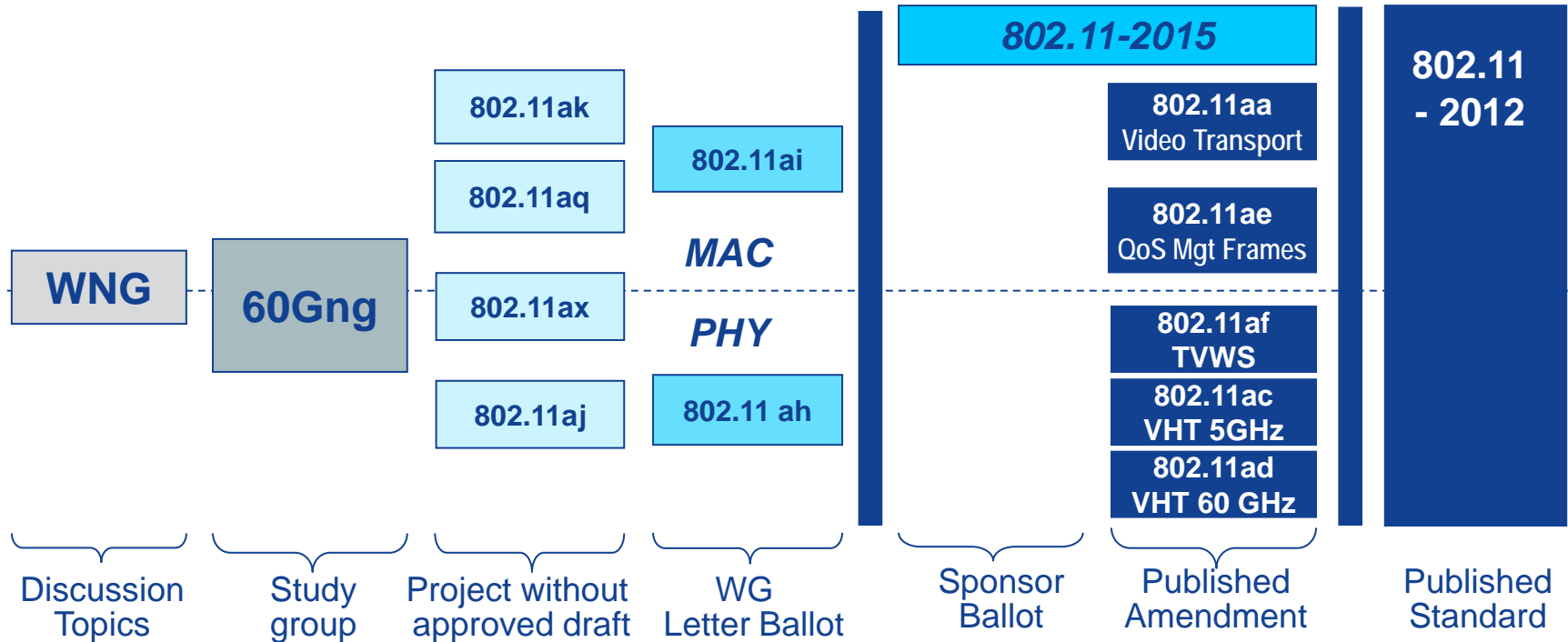

P802.11ax - High Efficiency WLAN

Directions for the next generation 2.4 & 5 GHz Wi-Fi radio interface

- There is no drive to increase peak data rates beyond what is already available by .11ac
 - Potentially adopting advanced .11ac functionalities for 2.4 GHz
- The key point is the increasing usage of 802.11 in uncoordinated high density scenarios
 - Contributions to HEW have shown that properly managed Wi-Fi networks can well mitigate the issues
- Three key focus points:
 - (1) To improve efficiency in dense networks with large no. of STAs
 - (2) To improve efficiency in dense heterogeneous networks with large no. of APs
 - (3) To improve efficiency in outdoor deployments
- The aim is to achieve a substantial increase in the real-world throughput achieved
 - Creating an instantly recognizable improvement in QoE (cell edge behavior)
 - Generating spatial capacity increase (area throughput)
- The standard may be ratified in ~ 2017

No major breakthrough in Wi-Fi, but a recognizable gradual enhancement

Standards Evolution

IEEE 802.11 SPECIFICATIONS

IEEE 802.11 Specifications

IEEE 802.11-1997	Wireless LAN Medium Access Control (MAC) and Physical Layer (PHY) specifications	Jul 1997
IEEE 802.11a	High-speed Physical Layer in the 5 GHz Band (54 Mbps in 5GHz)	Sep 1999
IEEE 802.11b	Higher-Speed Physical Layer Extension in the 2.4 GHz Band (11 Mbps in 2.4 GHz)	Sep 1999
IEEE 802.11c	<i>Support of the Internal Sublayer Service to cover bridge operations with 802.11 MAC => IEEE 802.1D</i>	Oct 1998
IEEE 802.11d	Specification for operation in additional regulatory domains	Jun 2001
IEEE 802.11e	Medium Access Control (MAC) Quality of Service Enhancements	Nov 2005
IEEE 802.11F	Inter-Access Point Protocol => <i><u>Withdrawn February 2006</u></i>	Jul 2003
IEEE 802.11g	Further Higher Data Rate Extension in the 2.4 GHz Band (54 Mbps in 2.4 Ghz)	Jun 2003
IEEE 802.11h	Spectrum and Transmit Power Management Extensions in the 5 GHz band in Europe	Oct 2003
IEEE 802.11i	Medium Access Control (MAC) Security Enhancements	Jul 2004
IEEE 802.11j	4.9 GHz–5 GHz Operation in Japan	Oct 2004
IEEE 802.11-2007	Wireless LAN Medium Access Control (MAC) and Physical Layer (PHY) Specifications	Jun 2007

IEEE 802.11 Specifications, continuation

IEEE 802.11-2007	Wireless LAN Medium Access Control (MAC) and Physical Layer (PHY) spec	Jun 2007
IEEE 802.11k	Radio Resource Measurement of Wireless LANs	Jun 2008
IEEE 802.11n	Enhancements for Higher Throughput (4x 150 Mbps in 2.4/5GHz)	Oct 2009
IEEE 802.11p	WAVE—Wireless Access for the Vehicular Environment	Jul 2010
IEEE 802.11r	Fast Basic Service Set (BSS) Transition	Jul 2008
IEEE 802.11s	Mesh Networking	Sep 2011
IEEE 802.11T	Wireless Performance Prediction (WPP) => <u>Cancelled</u>	
IEEE 802.11u	Interworking with External Networks	Feb 2011
IEEE 802.11v	IEEE 802.11 Wireless Network Management	Feb 2011
IEEE 802.11w	Protected Management Frames	Sep 2009
IEEE 802.11y	3650–3700 MHz Operation in USA	Nov 2008
IEEE 802.11z	Extensions to Direct Link Set-up (DLS)	Oct 2010
IEEE 802.11-2012	Wireless LAN Medium Access Control (MAC) and Physical Layer (PHY) Specifications	Mar 2012

IEEE 802.11 Specifications, continuation

IEEE 802.11-2012	Wireless LAN Medium Access Control (MAC) and Physical Layer (PHY) spec	Mar 2012
IEEE 802.11aa	MAC Enhancements for Robust Audio Video Streaming	May 2012
IEEE 802.11ad	Enhancements for Very High Throughput in the 60 GHz Band	Dec 2012
IEEE 802.11ae	Prioritization of Management Frames	Apr 2012
IEEE 802.11ac	Enhancements for Very High Throughput for Operation in Bands below 6 GHz	Dec 2013
IEEE 802.11af	TV White Spaces Operation	Dec 2013
P802.11ah	Sub 1 GHz license-exempt operation	~ 03/2016
P802.11ai	Fast Initial Link Set-up	~ 11/2015
P802.11aj	China Milli-Meter Wave (CMMW)	~ 10/2016
P802.11ak	Enhancements For Transit Links Within Bridged Networks	~ 2016
P802.11aq	Pre-Association Discovery (PAD)	~ 05/2016
P802.11ax	High Efficiency WLAN	~ 03/2017

NOKIA